

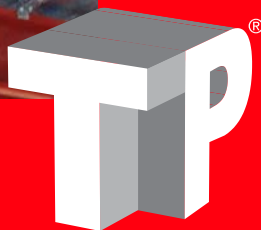

TP



Interlocked



Platforms

Portapalmet
cantilever
pallet rack
Kragarmregal
Special
Projects
Modul
Easy
Pallet

Industrial



Platforms

 **Il Soppalco  unisce Estetica e Statica**

Una grande flessibilità d'impiego ed una sorprendente facilità di posa consente la realizzazione di strutture con elevate caratteristiche tecniche.

 **The  platform unites aesthetics and static**

Highly versatile and surprisingly easy to install, allowing the construction of any layout with the most demanding technical specifications.

 **La plateforme  joigne l'esthétique et la statique**

La grande flexibilité et la facilité de montage permettent la réalisation de structures à caractéristiques techniques exigeantes.

 **Die Bühne  vereinigt Ästhetik und Statik**

Die zahlreichen Anwendungsmöglichkeiten und die einfache Montage, erlauben die Realisierung von technisch hochwertigen Aufbauten bei geringen Kosten.



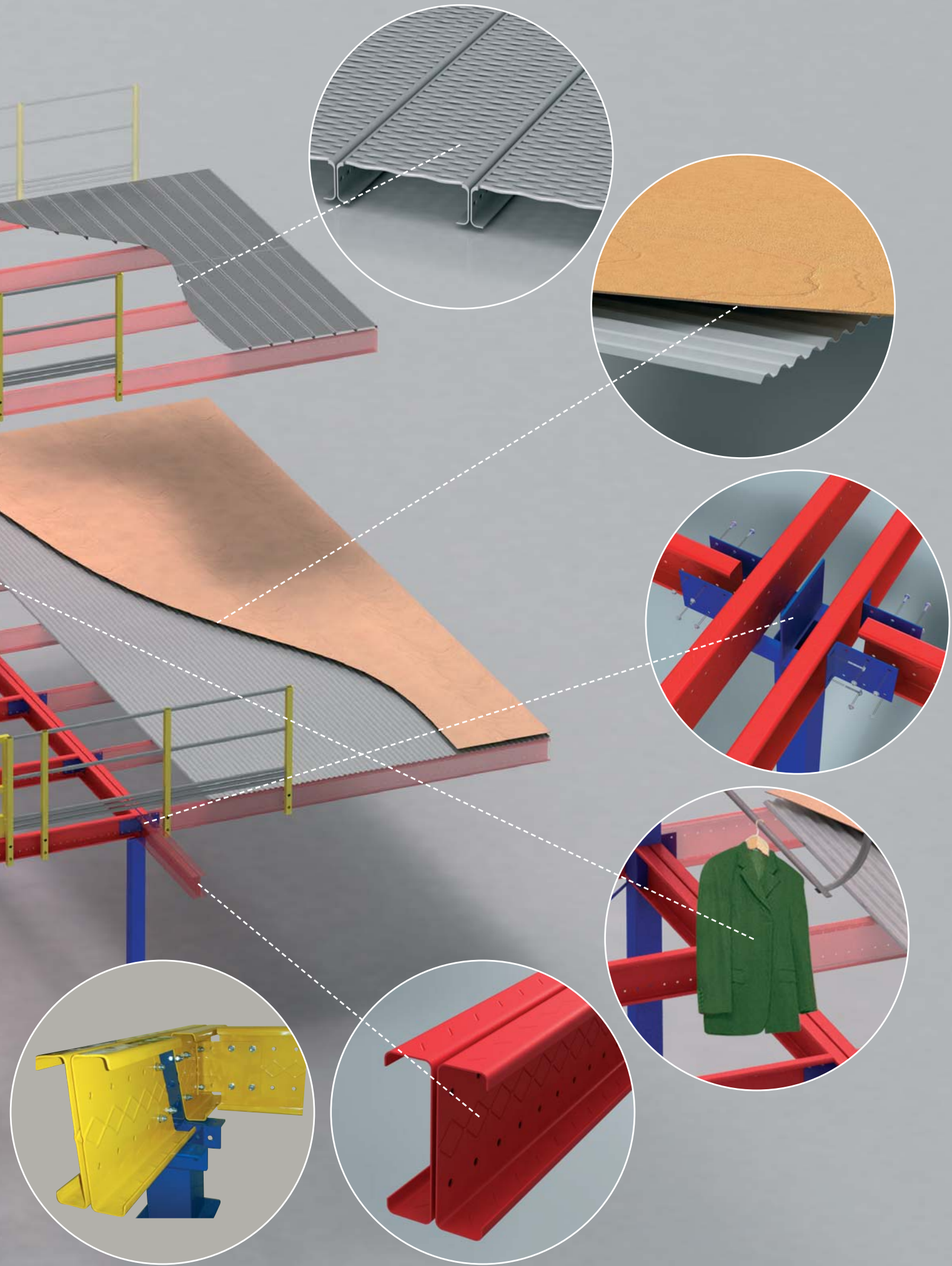

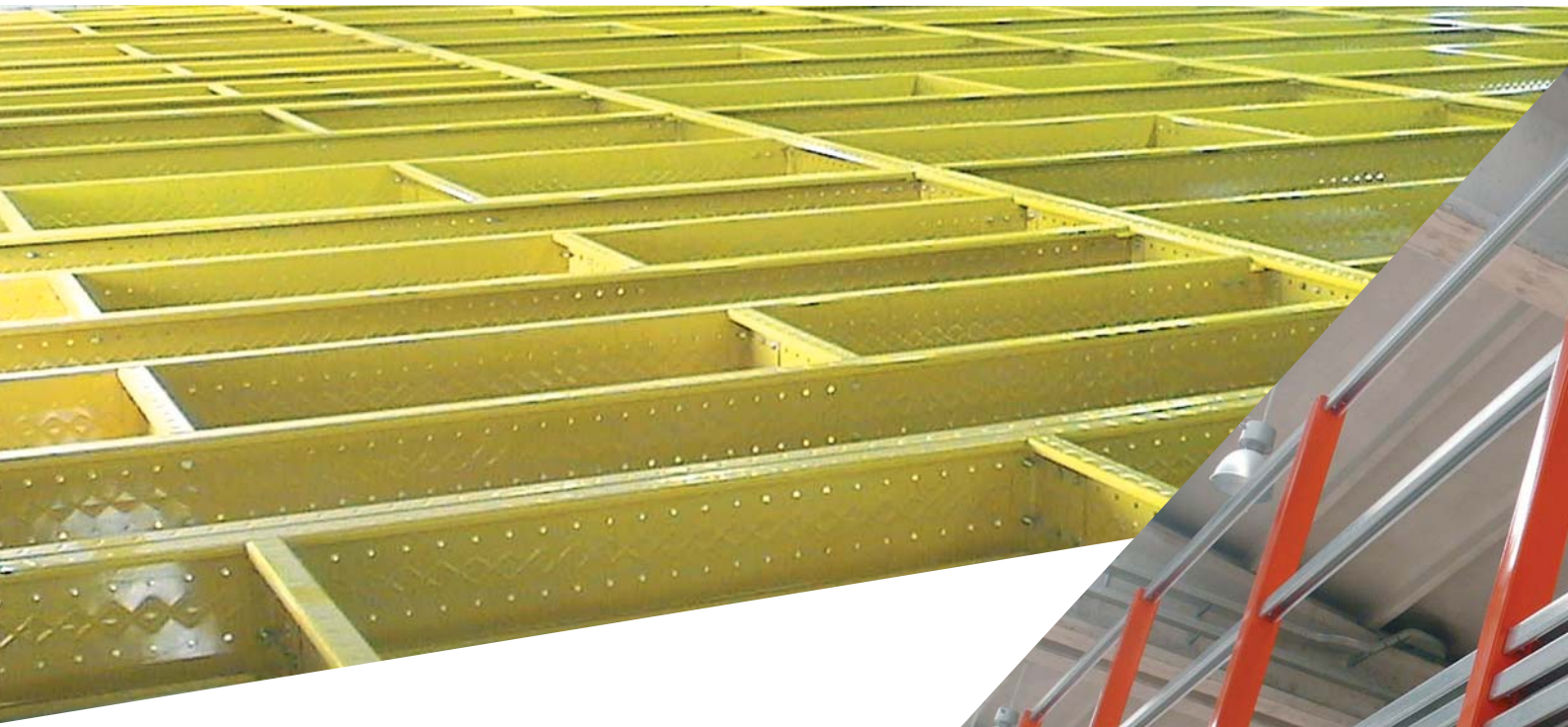















 L'innovativo sistema di deformazione a freddo del nastro d'acciaio, esclusiva della R & S Modulblok, consente la produzione delle travi  in linea continua con ottimo costo-prestazione.



Progettazione e calcolo delle innumerevoli configurazioni del sistema  con SW dedicati

 The innovative production system of all steel sections, developed by the ModulBlok R&D department, enables the production of  -beams with an excellent cost effectiveness.

The design and executive drawings of the  system are carried out with highly sophisticated dedicated software.

 Le système innovatrice de production des différents profils, une invention du département R&D Modulblok, permet la production des poutres  avec un rapport qualité-prix excellent.

Les études et les plans de configuration  sont réalisés avec un logiciel sophistiqué, spécifiquement mis à point pour ce produit.

 Die moderne Produktion von kaltgewalzten Stahlprofilen, entwickelt von Modulblok, garantiert die Herstellung  mit einem konkurrenzfähigen Preis-Leistungsverhältnis.

Konstruktionszeichnungen und Berechnungen  sind mit modernen Zeichnungs-Software ausgeführt

Interlocked

 I soppalchi MODULBLOK sono caratterizzati da una ottima flessibilità di realizzazione. L'utilizzo di acciai ad alta resistenza consente la costruzione di strutture con elevate caratteristiche tecniche.

 The high flexibility of MODULBLOK platforms is the main advantage of our product. The excellent quality of the raw material we used allows us to realise structures which presents high design features.

 La grande flexibilité des plateformes MODULBLOK est l'autout majeure notre produit. L'utilisation d'acier de haute résistance garantie la réalisation de structures d'excellente qualité technique.

 MODULBLOK Bühnen sind von einer hohen Ausführungs-Flexibilität gekennzeichnet. Die Benutzung von hochfesten Stählen erlaubt die Realisierung von technisch hochwertigen Aufbauten.

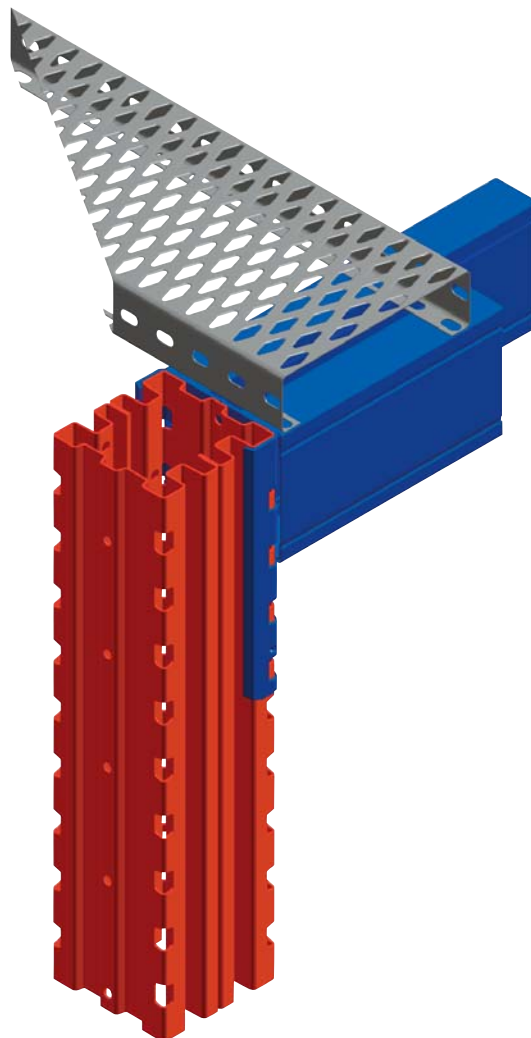

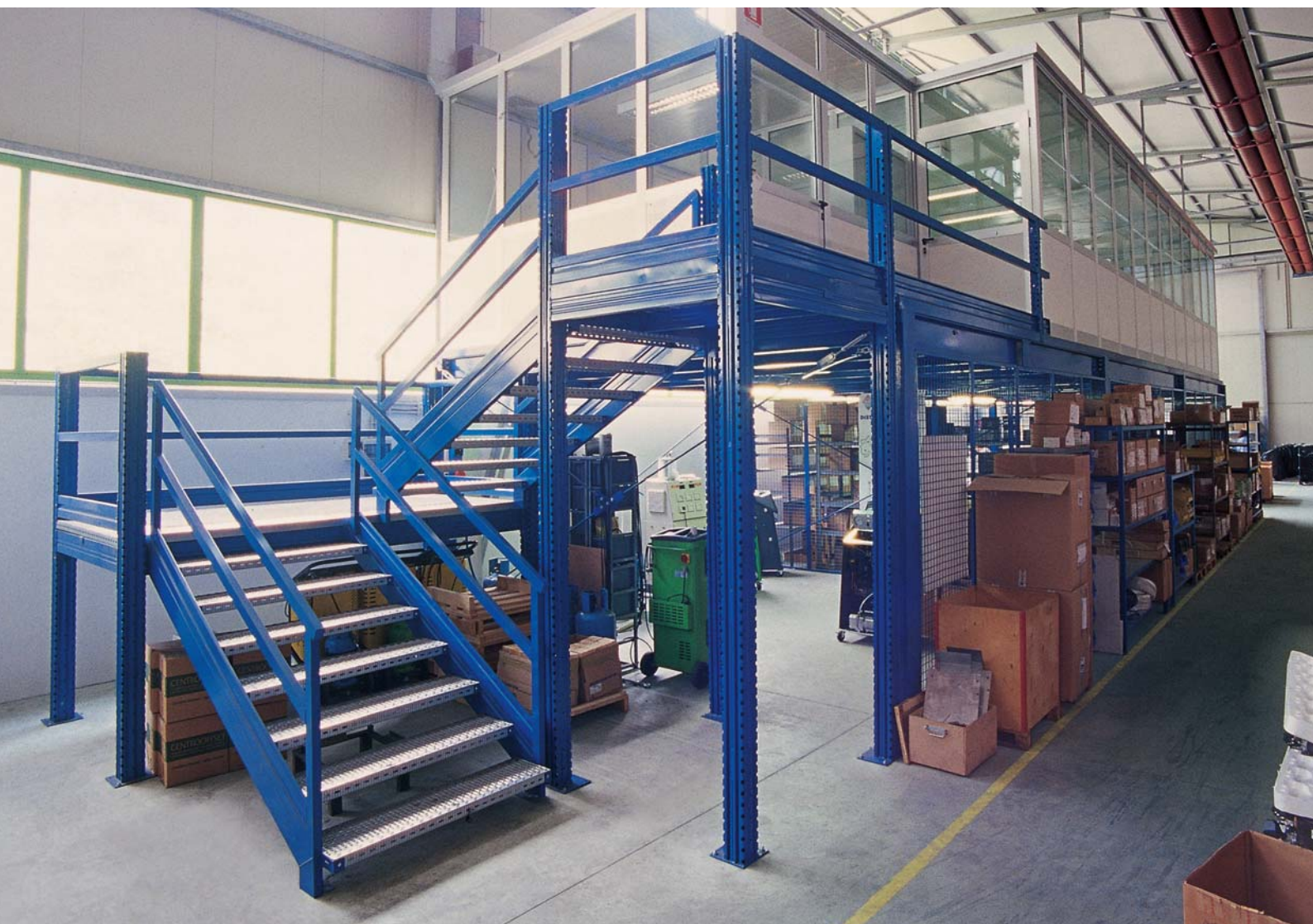

Industrial





Modulblok® S.p.A.
Tecnologie e logistiche di magazzino
33010 Castellerio di Pagnacco (Ud) Italy
Tel. +39 0432 660145 r.a. Fax +39 0432 661235
E-mail: mblok@modulblok.com
<http://www.modulblok.com>



ASSOCIAZIONE
 FRA I COSTRUTTORI
 IN ACCIAIO ITALIANI



sezione
 scaffalature industriali
 membro FEM
 Fédération européenne
 de la manutention
 ERF european racking federation



Modulblok S.p.A.
 socio



Ente Nazionale Italiano
 di Unificazione